

Bante920 Benchtop pH/ORP Meter

Instruction Manual

Introduction

Thank you for selecting the Bante920 benchtop pH/ORP meter. This manual provides a step-by-step guide to help you operate the meter, please carefully read the following instructions before use.

Unpacking

Before unpacking, ensure that the current work environment meets following conditions.

- Relative humidity is less than 80%.
- Ambient temperature is greater than 0°C and less than 60°C.
- No potential electromagnetic interference.

The following list describes the standard components of the meter. After the unpacking, please check all components are complete. If any are damaged or missing, please contact nearest distributor.

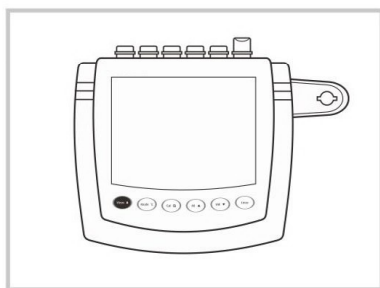

Bante920 pH/ORP Meter

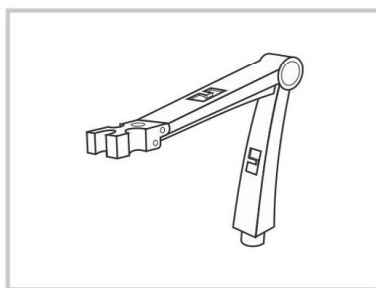

Electrode Arm

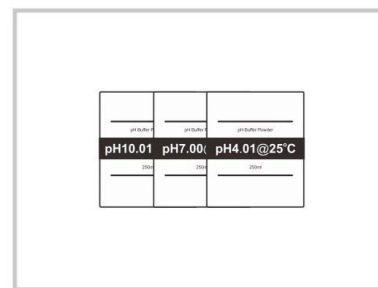

pH Buffer Pouches

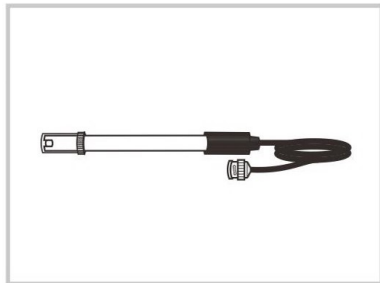

E201 pH Electrode

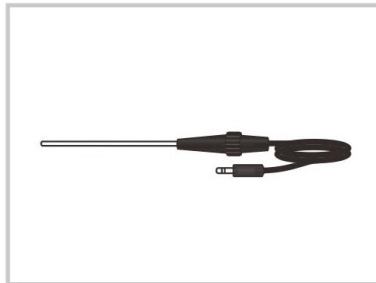

TP-10K Temperature Probe

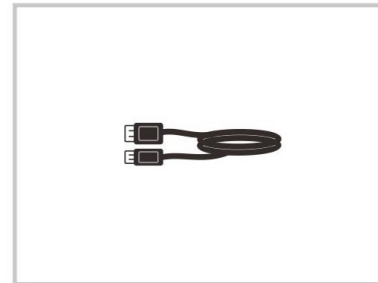

USB Cable

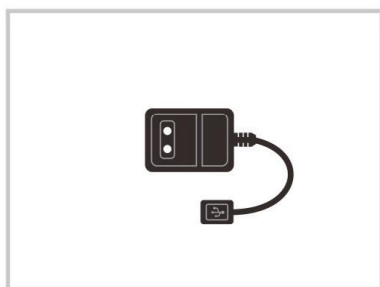









DC5V Power Adapter

Display







The Bante920 benchtop pH/ORP meter is equipped with an easy-read LCD display that used to show the measured values and mode icons. The following table describes the function of each icon.



INDEX:

 Measure	Measurement mode icon: Indicates the meter is in the measurement mode.	 Stable icon: Indicates the measuring value has stabilized.
 Calibration	Calibration mode icon: Indicates the meter is in the calibration mode.	 Hold icon: Indicates the measuring value has been locked.
 Setup	Setup mode icon: Indicates the meter is in the setting mode.	 Calibration Due Alarm: Prompts the user to calibrate the meter.
 Memory	Memory icon: Indicates the data is stored into memory.	ATC Automatic Temperature Compensation: Indicates the temperature compensation is enabled.
 Slope	Electrode slope icon: Indicates the average slope of the pH electrode.	

Keypad

KEY	FUNCTION
	<ul style="list-style-type: none"> Switches the meter ON/OFF. Locks the measured value, press the key again to resume measuring. Exits the calibration or setting and returns to measurement.
	<ul style="list-style-type: none"> Toggles between available measurement modes. Sets the temperature (Press and hold the key for 3 seconds).
	<ul style="list-style-type: none"> Starts calibration. Enters the setup menu (Press and hold the key for 3 seconds).
	<ul style="list-style-type: none"> Stores current reading to memory. Increase value or scroll up through the menu item.
	<ul style="list-style-type: none"> Views the calibration report or data logs. Decrease value or scroll down through the menu item.
	<ul style="list-style-type: none"> Confirms the calibration, settings or displayed options. Turn on/off the backlight (Press and hold the key for 3 seconds).

Connectors

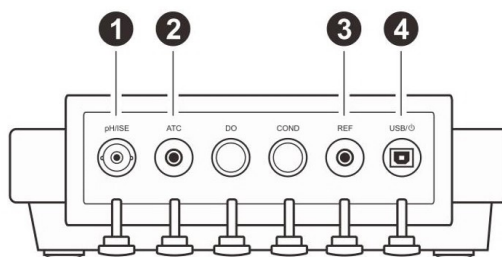

INDEX:

NO.	CONNECTOR	DESCRIPTION
1	pH/ISE	Used for connecting the pH or ORP electrode
2	ATC	Used for connecting the temperature probe
3	REF	Used for connecting the reference electrode
4	USB ⏻	Used for connecting the USB cable and DC5V power adapter

Installing the Electrode Holder

Take out the electrode arm from the packaging. The base plate of the electrode holder has a circular hole, the electrode arm has a connecting rod. Insert the connecting rod into the circular hole and swivel the electrode arm 90°. Electrode holder is now ready to swing into desired position.

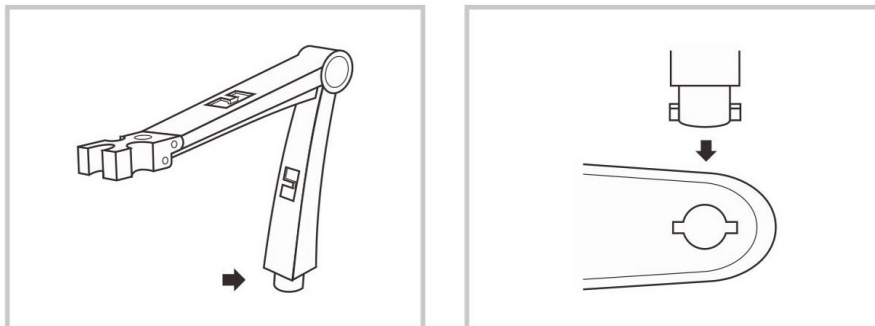

Adjustment of electrode arm

After installation, if the electrode arm automatically rises or falls, you need to adjust the screws until arm locate at any position.

1. Remove the plastic cover from the electrode arm.
2. Use the screwdriver to tighten the screw moderately.
3. Insert the plastic cover to previous position. Installation is completed.

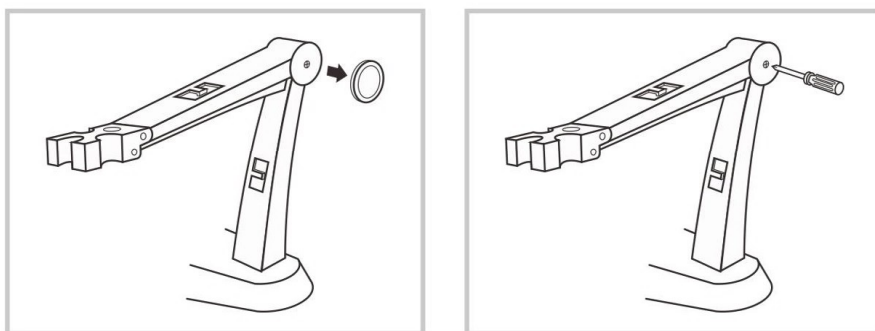

Connecting the Electrode

1. Take out the pH electrode from the packaging. Place the electrode into left or right side of the electrode arm.

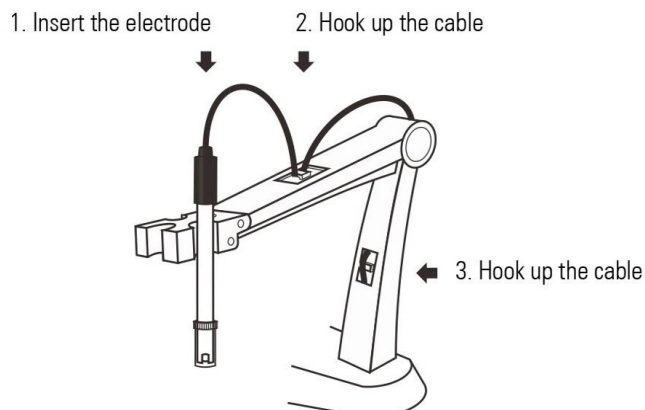

2. Insert the BNC connector into the connector socket labeled pH/ISE. Rotate and push the connector clockwise until it locks. After the connection is completed, DO NOT pull on the cable. Always make sure that the connector is clean and dry.

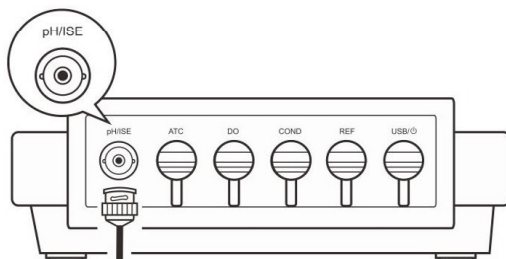

Connecting the Temperature Probe

1. Place the temperature probe into the circular hole of the electrode arm.

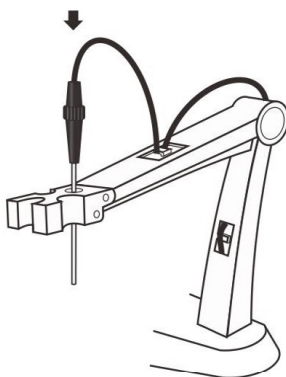

2. Insert the phone plug to the connector socket labeled ATC.

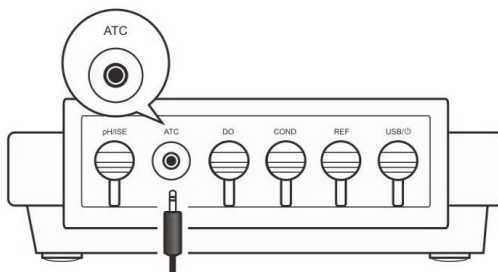

Connecting the Power Adapter

1. Connect the USB cable to power adapter.
2. Insert the other side of cable into the power socket. The meter is now ready for use.

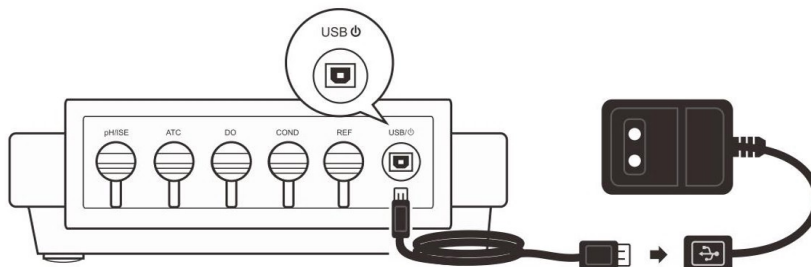

Prior to Use

Remove the protective cap from the bottom of the electrode.

- pH Electrode:
If the glass sensitive membrane has dried out, soak the electrode in 3M KCL solution (pH adjusted to 4.0) for at least 30 minutes.

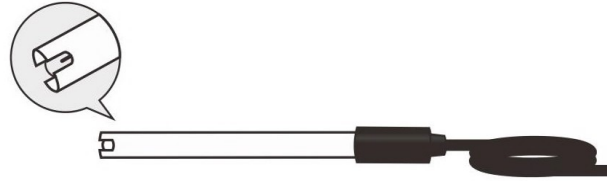

- ORP Electrode (purchase separately):
If the sensing element has dried out, soak the electrode in 4M KCL solution for at least 20 minutes.

Switching the Meter On and Off

- Press the **Meas** key to switch on the meter, the display shows the measured value.
- Press and hold the **Meas** key for 5 seconds, the meter will switch off.

Setup Menu

The Bante920 benchtop pH/ORP meter contains an integrated setup menu that is used to customize the displayed option to meet measurement requirements. In the different modes, the meter will show the corresponding options. The following table describes the functions of the menu items.

pH MODE:

MENU	DESCRIPTION	OPTIONS	DESCRIPTION	DEFAULT
<i>BUF</i>	pH Buffer: Set the pH buffer group for calibration and auto-recognition.	<i>USA</i>	USA (pH1.68/4.01/7.00/10.01/12.45)	USA
		<i>NIST</i>	NIST (pH1.68/4.01/6.96/9.18/12.45)	
		<i>DIN</i>	DIN (pH1.09/4.65/6.79/9.23/12.75)	
		<i>USER</i>	User-Defined	
<i>CAL</i>	Calibration Points: Set the number of calibration points.	<i>1</i>	1 point	3 points
		<i>2</i>	2 points	
		<i>3</i>	3 points	
		<i>4</i>	4 points	
		<i>5</i>	5 points	
<i>RESO</i>	Resolution: Set the resolution of the pH measurement.	<i>0.001</i>	0.001pH	0.001pH
		<i>0.01</i>	0.01pH	
		<i>0.1</i>	0.1pH	
<i>UNIT</i>	Measurement Unit: Set the default temperature unit.	<i>°C</i>	Degrees Celsius	°C
		<i>°F</i>	Degrees Fahrenheit	

ORP MODE:

MENU	DESCRIPTION	OPTIONS	DESCRIPTION	DEFAULT
RESO	Resolution: Set the resolution of the ORP measurement.	0.1	0.1mV	0.1mV
		1	1mV	

GENERAL OPTIONS:

MENU	DESCRIPTION	OPTIONS	DESCRIPTION	DEFAULT
STAB	Stability Criteria: When the LO option is enabled, the Stable icon will quickly appear on the display. When the HI option is enabled, the icon will take longer to appear, but guarantees high accuracy of the measurement.	LO	Low	Low
		HI	High	
HOLD	Auto-Hold: When the option is enabled, the meter will automatically sense a stable reading and lock the measurements.	YES	Enable	Disable
		NO	Disable	
OFF	Auto-Power Off: When the option is enabled, the meter will automatically turn off if no key is pressed within a specified time period.	10	10 minutes	Disable
		20	20 minutes	
		30	30 minutes	
		NO	Disable	
CALL	Calibration Due: When the option is enabled, if the meter does not calibrated within a specified time period, the meter will automatically show the  icon.	1...31	1 to 31 days	Disable
		OFF	Disable	
DATE	Date and Time: Set the current date and time.	---	Year-month-day, hour-minutes	
CLR	Clear Stored Data: Delete all stored readings in the memory.	YES	Enable	Disable
		NO	Disable	
RST	Factory Reset: If enabled, all of the calibration data and selected parameters will back to factory default settings, the meter must be recalibrated.	YES	Enable	Disable
		NO	Disable	

Setting the default option

- 1.1 If necessary, press the **Mode** key until the display shows desired measurement mode (e.g., pH).
- 1.2 Press and hold the  key for 3 seconds to enter the setup menu and the **▲** or **▼** key to select the menu item (e.g., BUF/P-01).
- 1.3 Press the **Enter** key, the display shows an option.
- 1.4 Press the **▲** or **▼** key to select the desired option.
- 1.5 Press the **Enter** key to confirm, the meter returns to the measurement mode. Setting is completed.

 If you want to exit the setting, press the **Meas** key.

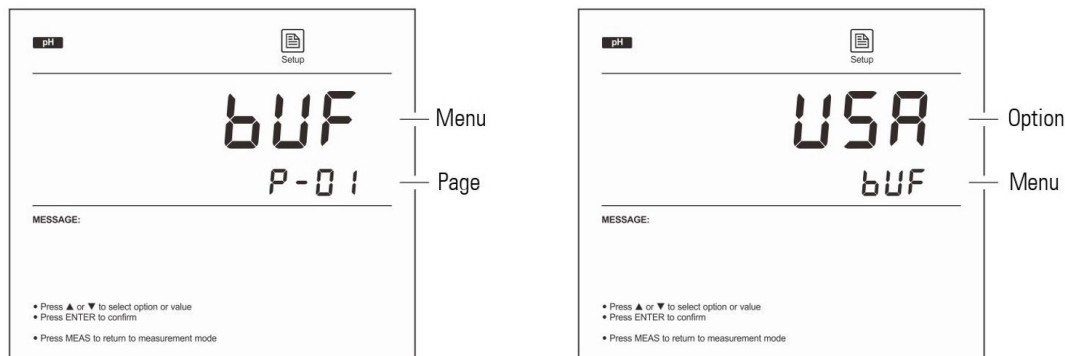

Setting the date and time

- 2.1 Press and hold the  key for 3 seconds to enter the setup menu and the **▲** or **▼** key until the display shows "DATE".
- 2.2 Press the **Enter** key, the meter shows current year (e.g., 2018).
- 2.3 Press the **▲** or **▼** key to set year and the **Enter** key to confirm, the display shows current date and time (Format: month-day, hour-minutes).
- 2.4 Press the **▲** or **▼** key to set the date and time, press the **Enter** key to confirm until the meter returns to the measurement mode. Setting is completed.



Temperature Compensation

For better accuracy, we recommend the use of either a sensor with a built-in or a separate temperature probe for the calibration or measurements.

Automatic Temperature Compensation

Connect the temperature probe to the meter (Refer to page 5 “Connecting the Temperature Probe”). The ATC icon immediately appears on the display, the meter is now switched to the automatic temperature compensation mode.

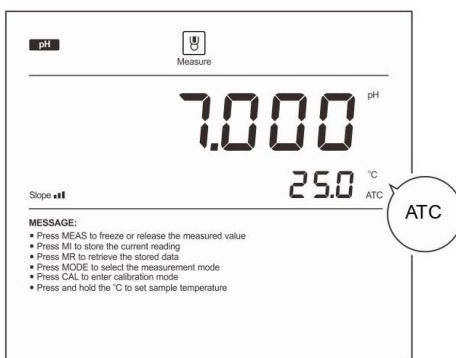

Manual Temperature Compensation

If the meter does not detect a temperature probe, the °C icon will show on the display indicating that the meter is switched to the manual temperature compensation mode. To set the temperature value of sample, follow the steps below.

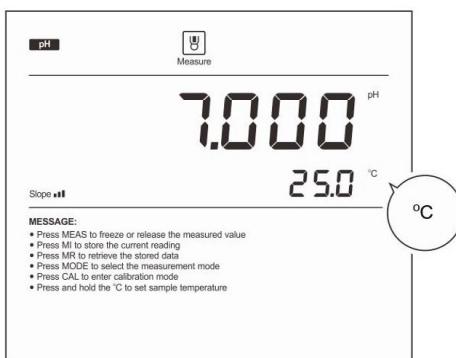

1. Press and hold the °C key for 3 seconds to enter the temperature setting mode.
2. Press the ▲ or ▼ key to modify the temperature value.
3. Press the **Enter** key to confirm.

i Press the ▲ or ▼ key once, the setting value will increase or decrease by 0.1. Press and hold the ▲ or ▼ key, the setting value will increase or decrease by 1.

pH Calibration

The Bante920 benchtop pH/ORP meter allows 1 to 5 points calibration in the pH mode. We recommend that you perform at least 2 points calibration for high accuracy measurement. The meter will automatically recognize and calibrate to following standard buffer values.

USA Standard Buffers	pH1.68, 4.01, 7.00, 10.01, 12.45
NIST Standard Buffers	pH1.68, 4.01, 6.86, 9.18, 12.45
DIN Standard Buffers	pH1.09, 4.65, 6.79, 9.23, 12.75

If the USER option is selected, the meter will allow only 2 points calibration. Single point calibration should only be carried out with pH7.00, 6.86 or 6.79, otherwise calibration will not be accepted.

Make sure to calibrate the meter when attaching a new electrode or during first use. DO NOT reuse the calibration solution after calibration, contaminants in solution will affect the calibration and eventually the accuracy of the measurement.

Single point calibration

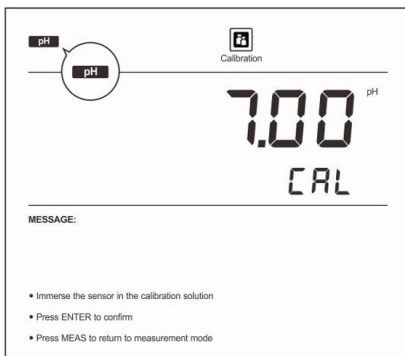

- 1.1 Press the **Mode** key until the meter shows **pH** icon and you have selected 1 point calibration in the setup menu.
- 1.2 Press the **Cal** key, the display shows pH7.00/CAL (or 6.86/CAL, or 6.79/CAL).



- 1.3 Rinse the pH electrode with distilled water, place the electrode (and temperature probe) into the pH7.00 (or 6.86, or 6.79) buffer solution. The end of the electrode must be completely immersed into the calibration solution. Stir the electrode gently to create a homogeneous solution. Press the **Enter** key, the Calibration icon begins flashing.

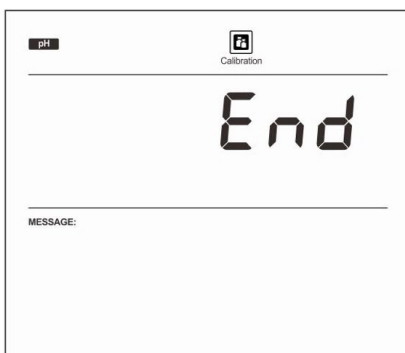

- 1.4 Wait for the reading to stabilize, the meter automatically shows END and returns to the measurement mode. Calibration is completed.

Multi-point calibration

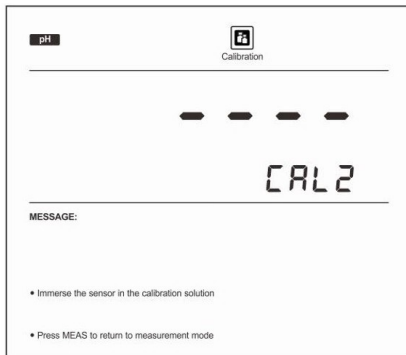

- 2.1 Ensure that you have selected 2 to 5 points calibration in the setup menu.
- 2.2 Repeat the steps 1.2 to 1.3 above. When the first calibration point is completed, the display will show CAL2. The meter prompts you to continue with second point calibration.



- 2.3 Rinse the pH electrode with distilled water, place the electrode (and temperature probe) into the next buffer solution. The meter will automatically recognize the calibration solution (e.g., pH4.01) and begins the calibration, the Calibration icon continuously flashing.

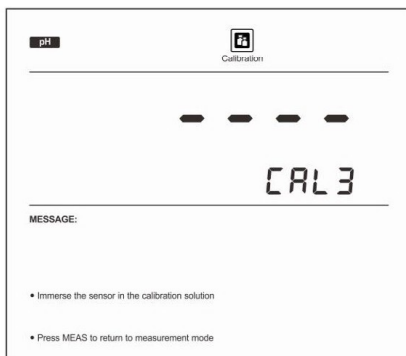

- 2.4 Wait for the reading to stabilize, the display will show CAL3. The meter prompts you to continue with third point calibration.
- 2.5 Repeat the step 2.3 above until the display shows END. The meter automatically returns to the measurement mode. Calibration is completed.

pH calibration with custom buffers

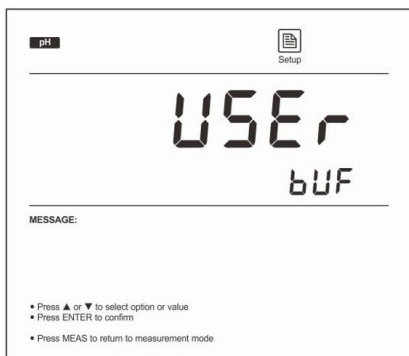

- 3.1 Ensure that you have selected the USER option in the setup menu. The calibration solutions should be at least 1 pH unit apart from each other.
- 3.2 Rinse the pH electrode with distilled water, place the electrode (and temperature probe) into the custom buffer solution. Stir the electrode gently and wait until the measurement is stable.



- 3.3 Press the **Cal** key, the meter enters the calibration mode.
- 3.4 If necessary, press the **▲** or **▼** key to set the calibration value, press the **Enter** key to begin the calibration (e.g., 6.00pH).



- 3.5 Wait for the reading to stabilize, the display shows CAL2. The meter prompts you to continue with second point calibration.
- 3.6 Rinse the pH electrode with distilled water, place the electrode (and temperature probe) into the next buffer solution and wait until the measurement is stable.
- 3.7 If necessary, press the **▲** or **▼** key to set the calibration value, press the **Enter** key to begin the calibration (e.g., 4.00pH).

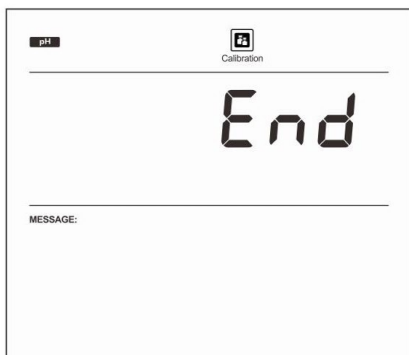

- 3.8 Wait for the reading to stabilize, the meter automatically shows END and returns to the measurement mode. Calibration is completed.



- During the calibration process, if the meter shows **Err**, please check the pH electrode and ensure the pH buffers are fresh and uncontaminated.
- If the electrode slope is not within the normal range (< 70% or >110%), the **Slope■■■** icon will disappear on the display.
- If you want to exit the calibration, press the **Meas** key.

Viewing the pH calibration report



4.1 Press the **MR** key in the pH measurement mode, the meter shows LOC/P-01.

4.2 Press the **▲** or **▼** key until the meter shows ELE/P-02.



4.3 Press the **Enter** key, the meter shows the last calibration date (Format: month-day).



4.4 Press the **▼** key, the meter shows the zero-point offset (e.g., 2mV).



4.5 Press the **▼** key, the meter shows the pH buffer group and slope (e.g., pH4-7, slope: 99.8%).

4.6 To exit the calibration report, press the **Meas** key.

i If the meter does not calibrated, the display will only show "----".

ORP Calibration

The Bante920 benchtop pH/ORP meter allows 1 point calibration in the relative mV mode, but calibration is not necessary unless exact readout agreement with a work standard and at a specific ORP value is needed.

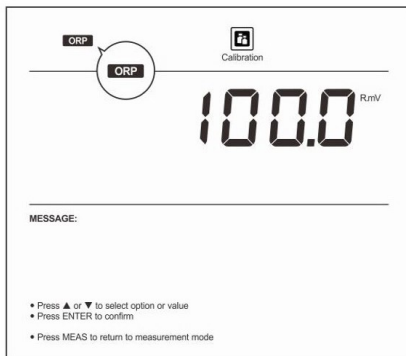

- 1.1 Press the **Mode** key until the meter shows **ORP** icon.
- 1.2 Rinse the ORP electrode with distilled water, place the electrode into the calibration solution. Stir the electrode gently and wait until the measurement is stable.
- 1.3 Press the **Cal** key, the meter enters the calibration mode.



- 1.4 Press the **▲** or **▼** key to set the displayed value (e.g., 105 R.mV).
- 1.5 Press the **Enter** key to confirm, the Calibration icon begins flashing.

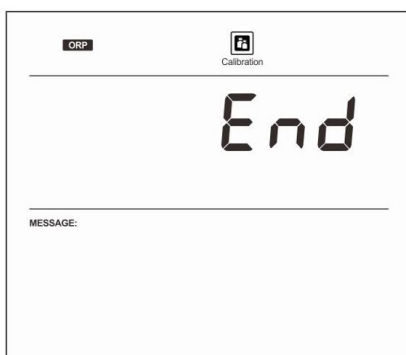

- 1.6 Wait for the reading to stabilize, the meter automatically shows END and returns to the measurement mode. Calibration is completed.

Viewing the ORP calibration report



- 2.1 Press the **MR** key in the ORP measurement mode, the display shows LOC/P-01.
- 2.2 Press the ▲ or ▼ key until the display shows ELE/P-02.



- 2.3 Press the **Enter** key, the display shows the last calibration date (Format: month-day).

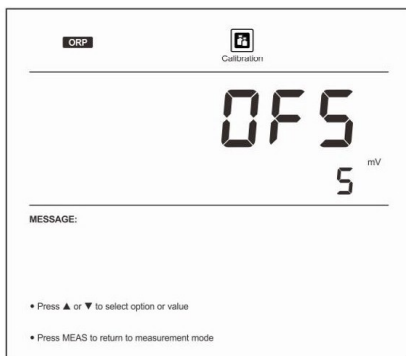

- 2.4 Press the ▼ key, the display shows the offset potential (e.g., 5mV).
- 2.5 To exit the calibration report, press the **Meas** key.

Temperature Calibration

During the measurement process, if the temperature reading displayed differs from that of an accurate thermometer, the meter needs to be calibrated.

1. Connect the temperature probe to the meter and place into a solution with a known accurate temperature.
2. Press and hold the °C key for 3 seconds to enter the temperature setting mode.
3. Press the ▲ or ▼ key to set the temperature value.
4. Press the **Enter** key to confirm. Calibrating is completed.

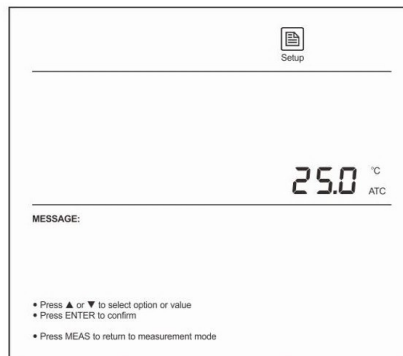

- ① During the setting process, press the ▲ or ▼ key once, the setting value will increase or decrease by 0.1. Press and hold the ▲ or ▼ key, the setting value will increase or decrease by 1.

pH Measurement

1. Press the **Mode** key until the display shows **pH** icon.
2. Rinse the pH electrode with distilled water. Place the electrode (and temperature probe) into the sample solution, stir the electrode gently.
3. Record the measured value when the reading is stable.

ORP Measurement

The Bante920 benchtop pH/ORP meter provides two millivolt measurement modes.

- Press the **Mode** key until the display shows measurement unit "mV", the meter is now enters the absolute mV measurement mode.
- Press the **Mode** key until the display shows **ORP** icon, the meter is now enters the relative mV measurement mode.

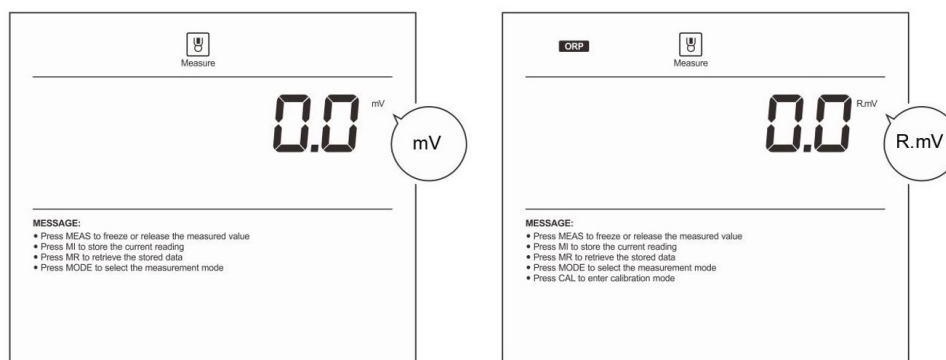

- Select one of the above modes. Place the ORP electrode into the sample. Record the measured value when the reading is stable.

Auto-Hold

The meter contains an Auto-Hold function. If enabled, the meter will automatically sense a stable reading and lock the measurements, the HOLD icon appears on the display. If disabled, press the **Hold** key, the meter will immediately lock the displayed value. Press the **Meas** key to resume measuring.

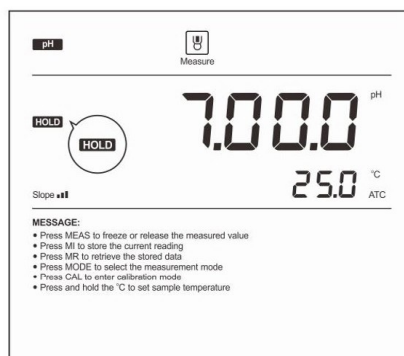

Storing and Recalling Data



The Bante920 benchtop pH/ORP meter is capable of storing and recalling up to 500 data sets.

Storing readings into memory

During the measurement process, press the **MI** key to store the reading into the memory, the Memory icon appears on the display.



Viewing stored readings

1. Press the **MR** key in the measurement mode, the meter shows LOC/P-01 (Data Log).
2. Press the **Enter** key, the meter shows the serial number of the stored data.

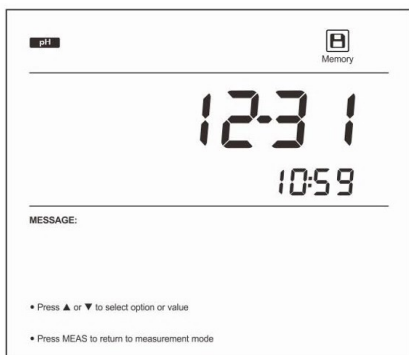

3. Press the ▼ key, the meter shows the date and time of the stored data (Format: month-day, hour-minutes).



4. Press the ▼ key, the meter shows the stored data.
5. Press the ▼ key again, the meter shows next data set.
6. Press the **Meas** key, the meter returns to the measurement mode.

Clearing the memory

Please refer to page 6 SETUP MENU.

Communication

Bante Instruments provides a Data Acquisition System that can be used to transfer data, receive the measuring values or import the data to Excel. You are able to download this software from our official website at [http://www.banteinstruments.com](#). Before installation, ensure that Windows 7/8/10 operating system has been installed on your computer.

Receiving data

- Connect the USB cable to meter and computer. Click the DAS icon, the system will automatically scan an available communication port and show the message box "Found a port on your computer".
- Click the **OK** button, the application starts.

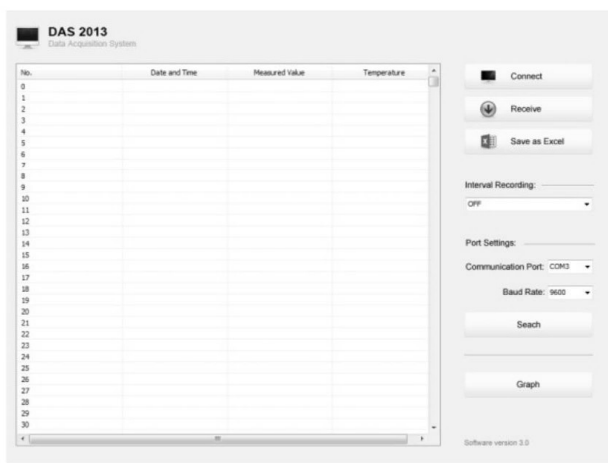

- Click the **Connect** button, the screen shows "Port is connected" indicate that the communication between the meter and the computer has been established.
- Click the **OK** button to confirm.
- Click the **Receive** button, the stored data automatically transfer to computer.

Interval recording

This function is used for recording the measuring value within the specify time period.

- Click the **Interval Recording** button and select a time option.
- Click the **Receive** button, the measured value will automatically send to data sheet.



- The first data need 1 minute to be shown on screen.
- Do not press any key on meter during the Interval Recording mode, it will cause communication interruption.

Graph mode

This function is used for viewing the variations of the measured parameter continuously.

Click the **Graph** button, the screen immediately shows the curve graph. To quit current mode, click the **Back** button.

Create the excel file

When the transfer is completed, click the **Save as Excel** button, the measured values in the data sheet will automatically convert to Excel file.



- Once the software is closed, all received data will be lost and can not be recovered.

Electrode Care and Maintenance

pH electrode

Since pH electrode is susceptible to dirt and contamination, clean as necessary depending on the extent and condition of use.

- After measuring: rinse the electrode in distilled water, store the electrode into the 3M KCL solution.
- Salt deposits: soak the electrode in warm tap water to dissolve deposits, then thoroughly rinse with distilled water.
- Oil or Grease film: wash the glass sensitive membrane of electrode gently in some detergents and water. If necessary, using the alcohol to clean the sensitive membrane, then rinse with distilled water. Place the electrode in the 3M KCL solution for at least 30 minutes.
- Clogged reference junction: heat a diluted KCl solution to 60°C to 80°C. Place the electrode into the heated solution for about 10 minutes. Allow the electrode to cool in some unheated KCl solution.
- Protein deposits: prepare a 1% pepsin solution in 0.1M of HCL. Place the electrode in the solution for 10 minutes. Rinse the electrode with distilled water.

Reactivating the pH Electrode:

If stored and cleaned properly, the electrode should be ready for immediate use. However, a dehydrated sensitive membrane may cause sluggish response. To rehydrate the sensitive membrane, immerse the electrode in a pH4.01 buffer solution for 10 to 30 minutes. If this fails, the electrode requires activation.

1. Soak the electrode in 0.1M HCl for 5 minutes.
2. Remove and rinse with deionized water, then place in 0.1M NaOH for 5 minutes.
3. Remove and rinse again, and soak in 3M KCL solution for at least 30 minutes.

ORP electrode

- Ensure that the ORP electrode is thoroughly washed with distilled water after use.
- In aggressive chemicals, dirty or viscous solutions, and solutions with heavy metals or proteins, take readings quickly and rinse electrode immediately.
- If you do not use the electrode for long periods, store the electrode with 4M KCL solution.

Cleaning the Electrode:

Contamination of the sensing element often results in slow response and inaccurate readings. If necessary, clean the element by one of the following procedures.

Inorganic Deposits:

- 1.1 Soak the ORP electrode in 0.1M HCl for 10 minutes.
- 1.2 Remove and rinse with distilled water, then place in alcohol for 5 minutes.
- 1.3 Remove and rinse again, and soak in pH4.01 buffer solution for 15 minutes.

Oil and Grease Films:

- 2.1 Wash the electrode gently in some detergents and water.
- 2.2 Dip the electrode in the 4M KCL solution for at least 30 minutes.

Troubleshooting

LCD DISPLAY	CAUSE	CORRECTIVE ACTION
---	Electrode dried out	Soak the pH electrode in 3M KCL solution at least 30 minutes.
	Measured value is out of range	Check the electrode whether clogged, dirty or broken.
Err	Incorrect calibration solutions	Using the fresh calibration solutions for calibration.
	pH electrode has expired	Replace the pH electrode.

Specifications

pH	Model	Bante920
	Range	-2.000~20.000pH
	Accuracy	±0.002pH
	Resolution	0.1, 0.01, 0.001pH
	Calibration Points	1 to 5 points
	pH Buffer Options	USA (pH1.68/4.01/7.00/10.01/12.45)
		NIST (pH1.68/4.01/6.86/9.18/12.45)
		DIN (pH1.09/4.65/6.79/9.23/12.75)
Temperature Compensation	0~100°C, 32~212°F, Manual or Automatic	
mV	Range	-1999.9~1999.9mV
	Accuracy	±0.2mV
	Resolution	0.1, 1mV
	Calibration Points	1 point (Only for relative mV mode)
Temperature	Range	0~105°C, 32~221°F
	Accuracy	±0.5°C
	Resolution	0.1°C
	Calibration Points	1 point
General	Memory	Stores up to 500 data sets
	Output	USB communication interface
	Connector	BNC
	Display	LCD
	Operating Temperature	0~60°C
	Relative Humidity	< 80%
	Power Requirements	DC5V, using AC adapters, 220VAC/50Hz
	Dimensions	210 (L) × 188 (W) × 60 (H)mm
	Weight	1.5kg

Addendum 1: pH Electrode Selection Guide

The Bante920 benchtop pH/ORP meter comes with a general purpose pH electrode that is used to measure the pH of the liquids. If this electrode can not meet your measurement requirements, please refer to the table below to select an applicable probe.

SAMPLE TYPE	P11	P12	P13	P15	P16	P18	P19	P21	E201	E202
Agar										•
Beer	•	•	•					•	•	•
Blood Products	•	•	•					•		•
Bread, Dough						•	•			
Cement	•									
Cosmetics	•	•	•					•	•	•
Dairy Products	•	•	•				•			•
Education	•								•	•
Fats/Cream							•			
Field Use						•			•	•
Fish Products							•			•
Lab Flasks		•								
Low Ionic	•			•				•		
Meat, Cheese							•			•
Micro Samples			•							
Paint		•	•							•
Photographic										
Soil						•	•			
Surface										•
Test Tubes		•			•					
Tris Buffer					•					
Viscose Samples										•

Addendum 2: ORP Electrode Selection Guide

ORDER CODE	APPLICATION
501	Suitable for the sample with strong redox potential, plastic body, temperature range: 0~80°C
502	Suitable for the sample with weak redox potential, plastic body, temperature range: 0~80°C
504	Suitable for the high temperature samples, glass body, temperature range: 0~100°C

Addendum 3: Preparation of pH Buffer Solutions

- Open the pH7.00 buffer packet, place the reagent into a 250ml volumetric flask. Pour the distilled water 250ml to scale line, mix the solution until the reagent is completely dissolved.
- Preparation of pH4.01 and 10.01 standard buffer solutions are the same as above. Prepared standard buffer solutions should be stored in hermetically sealed glass containers.

pH Buffer 10	pH Buffer 7	pH Buffer Powder
pH10.01	pH7.00	pH4.01@25°C
250ml	250ml	250ml

Addendum 4: Preparation of ORP Standard Solutions

- Add 3 grams of quinhydrone to 500ml buffer pH4.01 and stir for 15 minutes. Un-dissolved quinhydrone powder must be present.
Potential @ 25°C = +263mV (± 10 mV)
- Add 3 grams of quinhydrone to 500ml buffer pH7.00 and stir for 15 minutes. There must be an excess of undissolved quinhydrone powder.
Potential @ 25°C = +87mV (± 10 mV)

Hazardous Substance Statement

Instruments is committed to the reduction and eventual elimination of all hazardous substances in both the manufacturing process and finished products we supply. We have an active manufacturing and procurement program to minimize and eliminate the use of harmful heavy metals such as cadmium, lead, mercury and the like. New technologies and design parameters are also promoting these efforts and we expect to have little or no such materials in our product in the coming years. We welcome our customer suggestions on how to speed up these efforts.



Warranty

The warranty period for meter is one year from the date of shipment. Above warranty does not cover the sensor and calibration solutions. Out of warranty products will be repaired on a charged basis. The warranty on your meter shall not apply to defects resulting from:

- Improper or inadequate maintenance by customer.
- Unauthorized modification or misuse.
- Operation outside of the environment specifications of the products.

For more information, please contact the nearest authorized distributor.