

Bante950 Benchtop Conductivity/TDS/Salinity Meter

Instruction Manual

Introduction

Thank you for selecting the Bante950 multiparameter conductivity meter. This manual provides a step-by-step guide to help you operate the meter, please carefully read the following instructions before use.

Unpacking

Before unpacking, ensure that the current work environment meets following conditions.

- Relative humidity is less than 80%.
- Ambient temperature is greater than 0°C and less than 60°C.
- No potential electromagnetic interference.

The following list describes the standard components of the meter. After the unpacking, please check all components are complete. If any are damaged or missing, please contact nearest distributor.

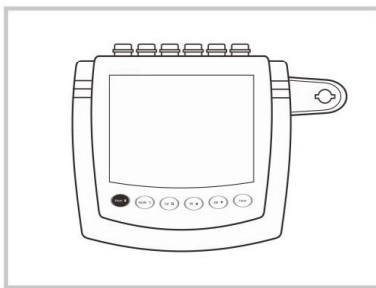

Bante950 Conductivity Meter

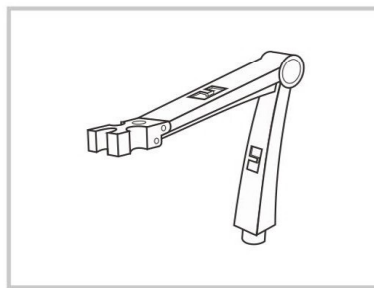

Electrode Arm

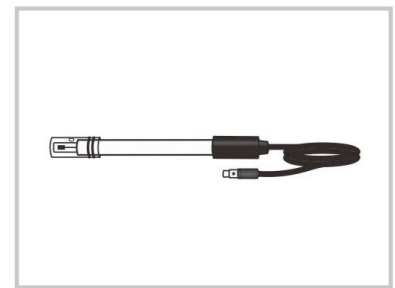

CON-1 Conductivity Electrode

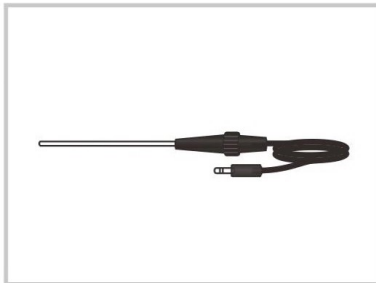

TP-10K Temperature Probe



Conductivity Standard Solutions

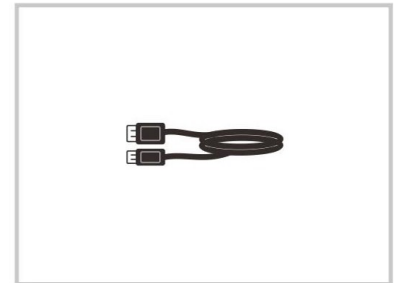

USB Cable

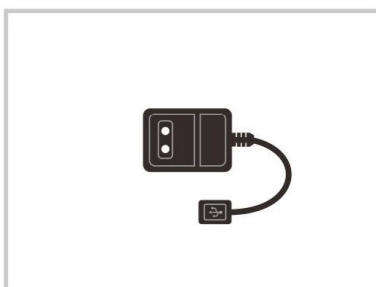







DC5V Power Adapter

Display







The Bante950 conductivity meter is equipped with an easy-read LCD display that used to show the measured values and mode icons. The following table describes the function of each icon.



INDEX:

 Measure	Measurement mode icon: Indicates the meter is in the measurement mode.	 Stable icon: Indicates the measuring value has stabilized.
 Calibration	Calibration mode icon: Indicates the meter is in the calibration mode.	 Hold icon: Indicates the measuring value has been locked.
 Setup	Setup mode icon: Indicates the meter is in the setting mode.	 Calibration Due Alarm: Prompts the user to calibrate the meter.
 Memory	Memory icon: Indicates the data is stored into memory.	ATC Automatic Temperature Compensation: Indicates the temperature compensation is enabled.

Keypad

KEY	FUNCTION
	<ul style="list-style-type: none"> Switches the meter ON/OFF. Locks the measured value, press the key again to resume measuring. Exits the calibration or setting and returns to measurement.
	<ul style="list-style-type: none"> Toggles between available measurement modes. Sets the temperature (Press and hold the key for 3 seconds).
	<ul style="list-style-type: none"> Starts calibration. Enters the setup menu (Press and hold the key for 3 seconds).
	<ul style="list-style-type: none"> Stores current reading to memory. Increase value or scroll up through the menu item.
	<ul style="list-style-type: none"> Views the calibration report or data logs. Decrease value or scroll down through the menu item.
	<ul style="list-style-type: none"> Confirms the calibration, settings or displayed options. Turn on/off the backlight (Press and hold the key for 3 seconds).

Connectors

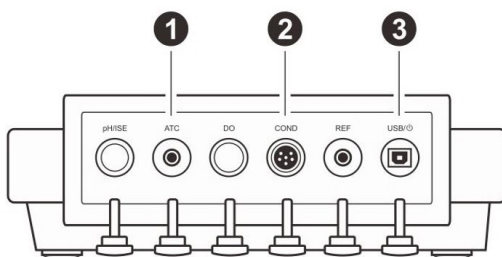

INDEX:

NO.	CONNECTOR	DESCRIPTION
1	ATC	Used for connecting the temperature probe
2	COND	Used for connecting the conductivity electrode
3	USB ⏻	Used for connecting the USB cable and DC5V power adapter

Installing the Electrode Holder

Take out the electrode arm from the packaging. The base plate of the electrode holder has a circular hole, the electrode arm has a connecting rod. Insert the connecting rod into the circular hole and swivel the electrode arm 90°. Electrode holder is now ready to swing into desired position.

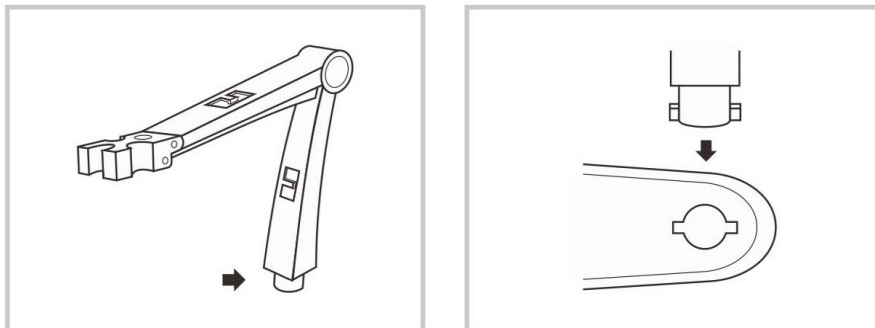

Adjustment of electrode arm

After installation, if the electrode arm automatically rises or falls, you need to adjust the screws until arm locate at any position.

1. Remove the plastic cover from the electrode arm.
2. Use the screwdriver to tighten the screw moderately.
3. Insert the plastic cover to previous position. Installation is completed.

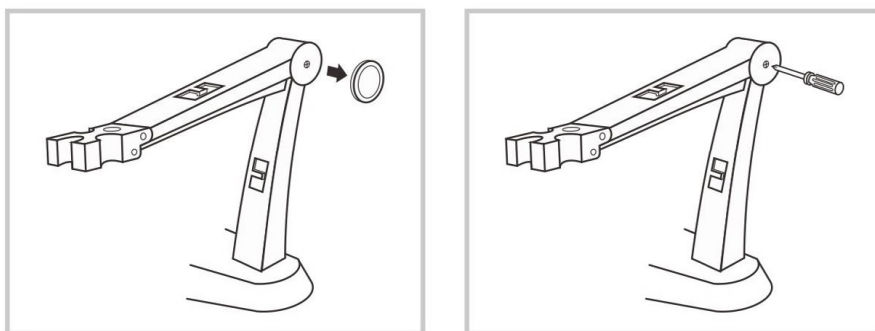

Connecting the Electrode

1. Take out the conductivity electrode from the packaging. Place the electrode into left or right side of the electrode arm.

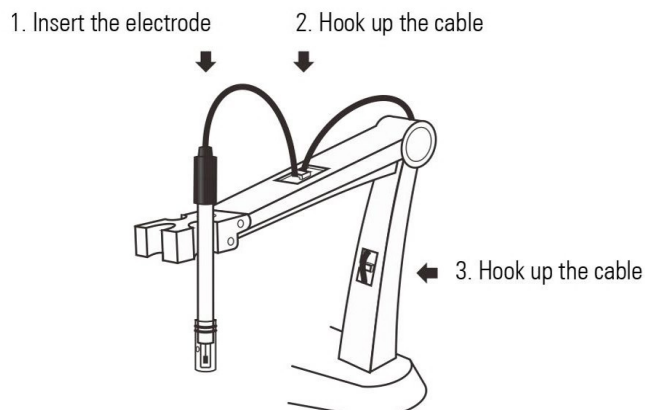

2. Insert the 6-pin connector into the connector socket labeled COND. Ensure the connector is fully seated. After the connection is completed, DO NOT pull on the cable. Always make sure that the connector is clean and dry.

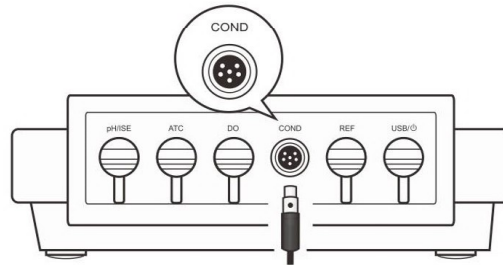

Connecting the Temperature Probe

1. Place the temperature probe into the circular hole of the electrode arm.

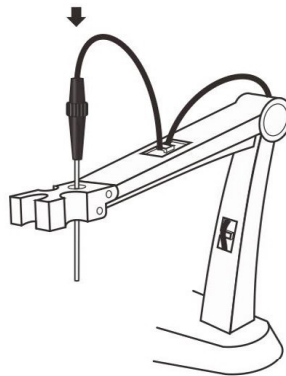

2. Insert the phone plug to the connector socket labeled ATC.

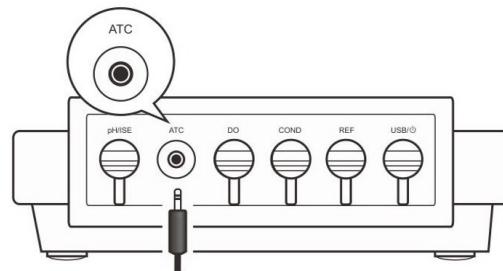

Connecting the Power Adapter

1. Connect the USB cable to power adapter.
2. Insert the other side of cable into the power socket. The meter is now ready for use.

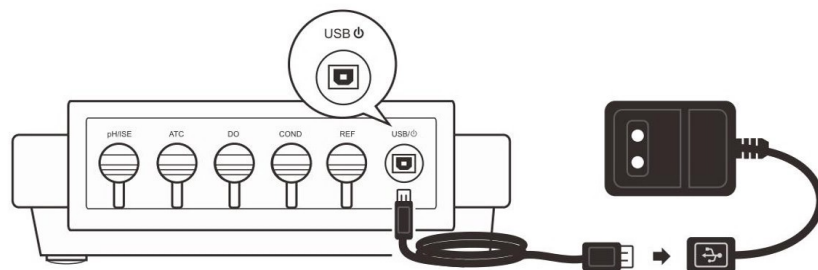

Prior to Use

Soak the conductivity electrode for a few minutes in tap water to remove dirt and oil stains on the electrode.

Switching the Meter On and Off

- Press the **Meas** key to switch on the meter, the display shows the measured value.
- Press and hold the **Meas** key for 5 seconds, the meter will switch off.





Setup Menu

The Bante950 conductivity meter contains an integrated setup menu that is used to customize the displayed option to meet measurement requirements. The following table describes the functions of the menu items.

MENU	DESCRIPTION	OPTIONS	DESCRIPTION	DEFAULT
CELL	Cell Constant: Set the cell constant to match connected electrode.	0.1	K=0.1	K=1
		1	K=1	
		10	K=10	
		USER	User-Defined	
COE	Temperature Coefficient: Set the linear temperature compensation coefficient.	2.10	Range: 0.0~10.0%/°C	2.10
CAL	Calibration Points: Set the number of calibration points.	1	1 point	1 point
		2	2 points	
		3	3 points	
		4	4 points	
		5	5 points	
PURE	Pure Water Coefficient: When the option is enabled, pure water coefficient will be applied automatically for ultra-pure water measurements.	YES	Enable	Disable
		NO	Disable	
Std	Reference Temperature: Set the normalization temperature for conductivity measurement and calibration.	25°C	25°C	25°C
		20°C	20°C	
TDS	TDS Factor: Set the default TDS conversion factor.	0.5	Range: 0.40~1.00	0.5
UNIT	Measurement Unit: Set the default temperature unit.	°C	Degrees Celsius	°C
		°F	Degrees Fahrenheit	
STA	Stability Criteria: When the LO option is enabled, the Stable icon will quickly appear on the display. When the HI option is enabled, the icon will take longer to appear, but guarantees high accuracy of the measurement.	LO	Low	Low
		HI	High	

<i>HOLD</i>	Auto-Hold: When the option is enabled, the meter will automatically sense a stable reading and lock the measurements.	<i>YES</i>	Enable	Disable
		<i>NO</i>	Disable	
<i>OFF</i>	Auto-Power Off: When the option is enabled, the meter will automatically turn off if no key is pressed within a specified time period.	<i>10</i>	10 minutes	Disable
		<i>20</i>	20 minutes	
		<i>30</i>	30 minutes	
		<i>NO</i>	Disable	
<i>CALL</i>	Calibration Due: When the option is enabled, if the meter does not calibrated within a specified time period, the display will automatically show the  icon.	<i>1...31</i>	1 to 31 days	Disable
		<i>OFF</i>	Disable	
<i>DATE</i>	Date and Time: Set the current date and time.	---	Year-month-day, hour-minutes	
<i>CLR</i>	Clear Stored Data: Delete all stored readings in the memory.	<i>YES</i>	Enable	Disable
		<i>NO</i>	Disable	
<i>rst</i>	Factory Reset: If enabled, all of the calibration data and selected parameters will back to factory default settings, the meter must be recalibrated.	<i>YES</i>	Enable	Disable
		<i>NO</i>	Disable	





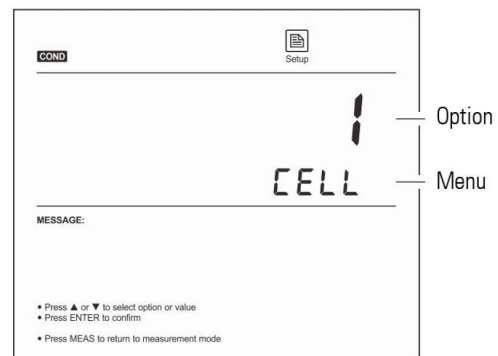
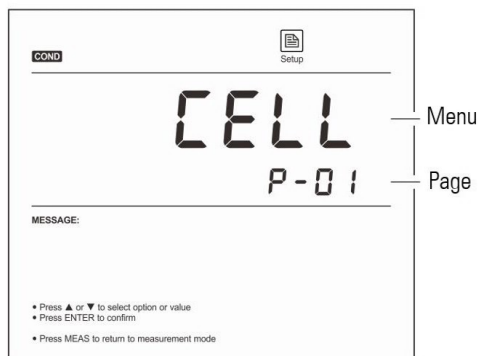

Setting the default option

- 1.1 Press and hold the  key for 3 seconds to enter the setup menu and the  or  key to select the menu item (e.g., CELL/P-01).
- 1.2 Press the **Enter** key, the display shows an option.
- 1.3 Press the  or  key to select the desired option.
- 1.4 Press the **Enter** key to confirm, the meter returns to the measurement mode. Setting is completed.

 If you want to exit the setting, press the **Meas** key.



Setting the date and time

- 2.1 Press and hold the  key for 3 seconds to enter the setup menu and the  or  key until the display shows DATE/P-12.
- 2.2 Press the **Enter** key, the meter shows current year (e.g., 2018).
- 2.3 Press the  or  key to set year and the **Enter** key to confirm, the display shows current date and time (Format: month-day, hour-minutes).
- 2.4 Press the  or  key to set the date and time, press the **Enter** key to confirm until the meter returns to the measurement mode. Setting is completed.



Temperature Compensation

For better accuracy, we recommend the use of either a sensor with a built-in or a separate temperature probe for the calibration or measurements.

Automatic Temperature Compensation

Connect the temperature probe to the meter (Refer to page 5 “Connecting the Temperature Probe”). The ATC icon immediately appears on the display, the meter is now switched to the automatic temperature compensation mode.

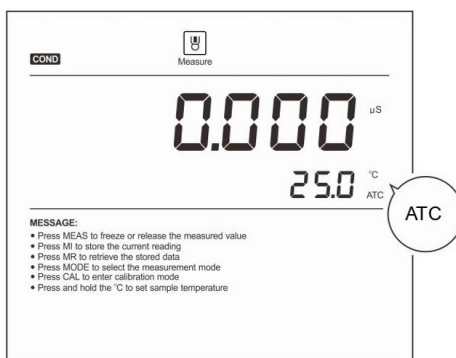

Manual Temperature Compensation

If the meter does not detect a temperature probe, the °C icon will show on the display indicating that the meter is switched to the manual temperature compensation mode. To set the temperature value of sample, follow the steps below.

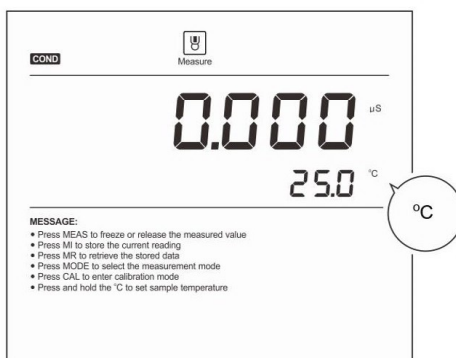

1. Press and hold the °C key for 3 seconds to enter the temperature setting mode.
2. Press the ▲ or ▼ key to modify the temperature value.
3. Press the **Enter** key to confirm.

i Press the ▲ or ▼ key once, the setting value will increase or decrease by 0.1. Press and hold the ▲ or ▼ key, the setting value will increase or decrease by 1.

Selecting the Conductivity Electrode

The Bante950 conductivity meter is capable of using the 3 types of conductivity electrodes. Prior to the calibration and measurement, you need to select the different sensors as per your sample concentration. The table below shows available electrode and its effective measuring ranges.

CONDUCTIVITY ELECTRODE	MEASURING RANGES	CELL CONSTANT
CON-0.1	0.1~100 μ S/cm	K=0.1
CON-1	10 μ S/cm~10mS/cm	K=1
CON-10	100 μ S/cm~200mS/cm	K=10

Automatic Calibration

Make sure that you selected the cell constant between 0.1, 1 or 10 in the setup menu. If the current option is "USER", the automatic calibration function will be disabled (Refer to chapter SETUP MENU).

The meter allows 1 to 5 points calibration in the automatic calibration mode. To ensure higher accuracy, we recommend that you perform 3 points calibration or select a standard value close to the sample value you are measuring. The meter will automatically detect these conductivity standard solutions and prompt the user to calibrate the meter. When the calibration is completed, all new calibration values will automatically override existing data.

The following table shows acceptable conductivity range of standard solution for each measuring range.

MEASURING RANGE	CALIBRATION SOLUTION RANGE	DEFAULT
0~20 μ S/cm	7~17 μ S/cm	10 μ S/cm
20~200 μ S/cm	70~170 μ S/cm	84 μ S/cm
200~2000 μ S/cm	700~1700 μ S/cm	1413 μ S/cm
2~20mS/cm	7~17mS/cm	12.88mS/cm
20~200mS/cm	70~170mS/cm	111.8mS/cm

Single point calibration

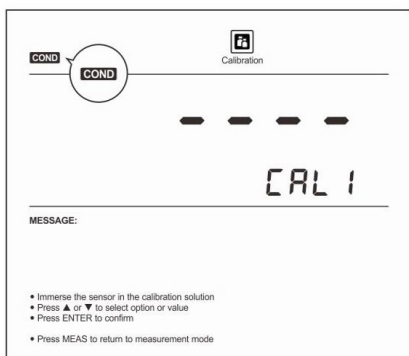

- 1.1 Make sure that you have selected 1 point calibration in the setup menu.
- 1.2 Rinse the conductivity electrode with distilled water, then rinse with a small amount of standard solution.
- 1.3 Press the **Cal** key, the display shows "CAL1" and waits for recognizing the standard solution.



- 1.4 Place the electrode into the conductivity standard solution, the meter automatically shows current calibration standard (e.g., 1413 μ S/cm).
- 1.5 If necessary, press the ▲ or ▼ key to set the calibration value.

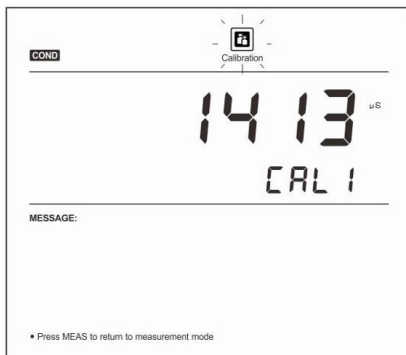

- 1.6 Press the **Enter** key, the Calibration icon begins flashing.

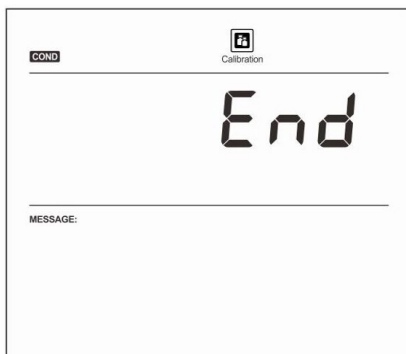

- 1.7 Wait for the reading to stabilize, the display automatically shows END. Single point calibration is completed.

Multi-point calibration

- 2.1 Ensure that you have selected 2 or 5 points calibration in the setup menu.
- 2.2 Repeat steps 1.2 to 1.6 above, when the first calibration point is completed, the display will show "CAL2". The meter prompts you to continue with second point calibration.
- 2.3 Rinse and place the electrode into the standard solution, the display automatically shows current calibration standard (e.g., 12.88mS/cm).
- 2.4 If necessary, press the ▲ or ▼ key to set the calibration value.
- 2.5 Press the **Enter** key, the Calibration icon begins flashing.
- 2.6 Wait for the reading to stabilize, the display will show "CAL3". The meter prompts you to continue with third point calibration.
- 2.7 Repeat the steps 2.3 and 2.5 above until the meter returns to the measurement mode. Calibration is completed.

Manual Calibration

The Bante950 conductivity meter provides an easy manual calibration mode. If the conductivity standard solution is not ready, you are able to use this method for calibration.

3.1 Record the cell constant value on the conductivity electrode (e.g., $K=1.01$).

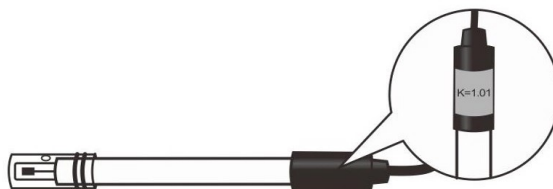

3.2 Press and hold the  key for 3 seconds to enter the setup menu, the display shows "CELL/P-01".

3.3 Press the **Enter** key, the meter enters the setting mode.

3.4 Press the **▲** or **▼** key until the display shows "User/Cell", press the **Enter** key to confirm.

3.5 Press the **▲** or **▼** key to set each digit according to previous record.

3.6 Press the **Enter** key to confirm until the setting values stop flashing. The meter returns to the measurement mode. Calibration is completed.

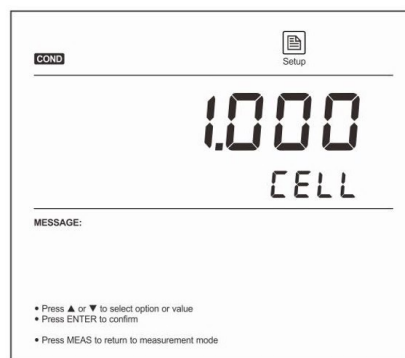
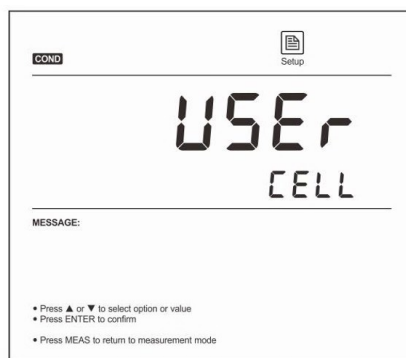
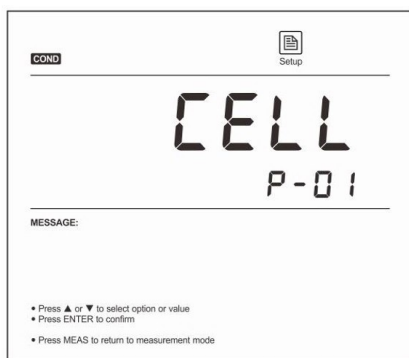

Exit the calibration

- During the calibration process, press the **Meas** key, the meter will exit the calibration and return to the measurement mode.
- Performing the conductivity calibration will simultaneously calibrate the corresponding TDS, salinity and resistivity values.

Viewing the calibration report



- 4.1 Press the **MR** key in the measurement mode, the display shows LOC/P-01.
- 4.2 Press the **▲** or **▼** key until the display shows ELE/P-02.



- 4.3 Press the **Enter** key, the display shows the last calibration date (Format: month-day).

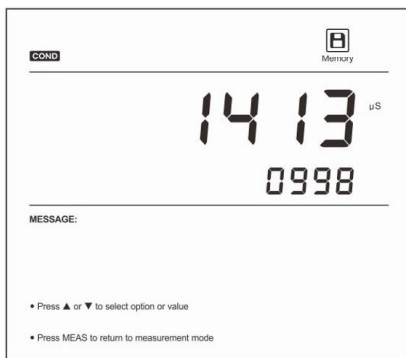

- 4.4 Press the **▼** key, the display shows the calibration point and calibration factor (e.g., K=0.998).
- 4.5 To exit the calibration report, press the **Meas** key.

Temperature Calibration

During the measurement process, if the temperature reading displayed differs from that of an accurate thermometer, the meter needs to be calibrated.

1. Connect the temperature probe to the meter and place into a solution with a known accurate temperature.
2. Press and hold the **°C** key for 3 seconds to enter the temperature setting mode.
3. Press the **▲** or **▼** key to set the temperature value.
4. Press the **Enter** key to confirm. Calibrating is completed.

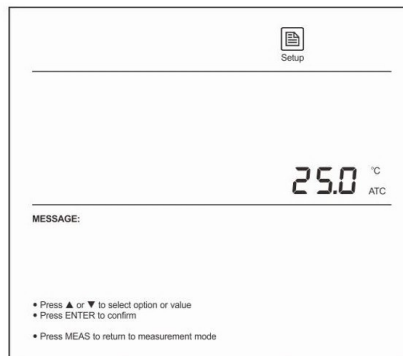

- ① During the setting process, press the **▲** or **▼** key once, the setting value will increase or decrease by 0.1. Press and hold the **▲** or **▼** key, the setting value will increase or decrease by 1.

Conductivity/TDS/Resistivity Measurement

1. Press the **Mode** key until the meter shows **COND** (Conductivity) or **TDS** (TDS) or **RES** (Resistivity) icon.



2. Rinse the conductivity electrode thoroughly with distilled water.
3. Place the electrode into the sample solution, stir the electrode gently.
4. Record the measured value when the reading is stable.

Salinity Measurement

The Bante950 conductivity meter provides two salinity measurement modes - practical salinity (unit: PSU) and natural seawater (unit: ppt).

1. Press the **Mode** key until the display shows **SAL** icon and measurement unit "PSU", the meter enters the practical salinity measurement mode.
2. If necessary, press the **Mode** key again, the meter shows **SAL** icon and measurement unit "ppt", the meter enters the seawater measurement mode.
3. Select the desired measurement mode. Place the electrode into the sample solution, stir the electrode gently.
4. Record the measured value when the reading is stable.

Auto-Hold

The meter contains an Auto-Hold function. If enabled, the meter will automatically sense a stable reading and lock the measurements, the HOLD icon appears on the display. If disabled, press the  key, the meter will immediately lock the displayed value. Press the **Meas** key to resume measuring.

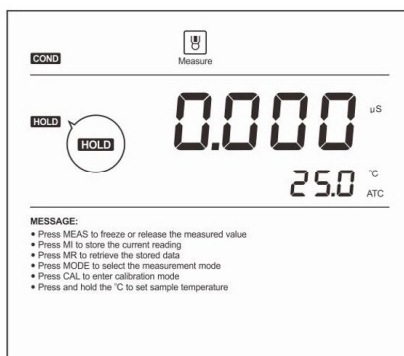

Storing and Recalling Data



The Bante950 conductivity meter is capable of storing and recalling up to 500 data sets.

Storing readings into memory

During the measurement process, press the **MI** key to store the reading into the memory, the Memory icon appears on the display.

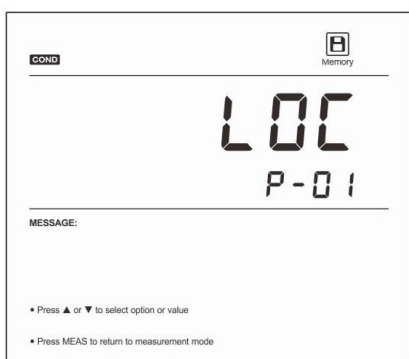

Viewing stored readings

1. Press the **MR** key in the measurement mode, the meter shows LOC/P-01 (Data Log).
2. Press the **Enter** key, the meter shows the serial number of the stored data.

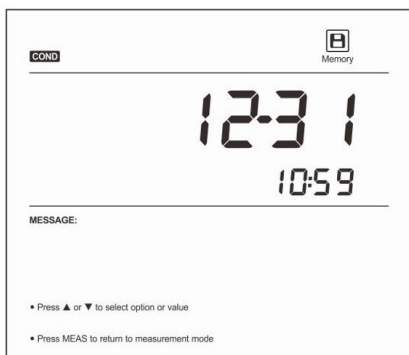

3. Press the ▼ key, the meter shows the date and time of the stored data (Format: month-day, hour-minutes).

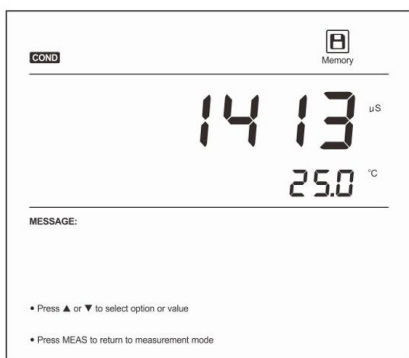

4. Press the ▼ key, the meter shows the stored data.
5. Press the ▼ key again, the meter shows next data set.
6. Press the **Meas** key, the meter returns to the measurement mode.

Clearing the memory

Please refer to page 6 SETUP MENU.

Communication

Bante Instruments provides a Data Acquisition System that can be used to transfer data, receive the measuring values or import the data to Excel. You are able to download this software from our official website at [http://www.banteinstruments.com](#). Before installation, ensure that Windows 7/8/10 operating system has been installed on your computer.

Receiving data

- Connect the USB cable to meter and computer. Click the DAS icon, the system will automatically scan an available communication port and show the message box "Found a port on your computer".
- Click the **OK** button, the application starts.

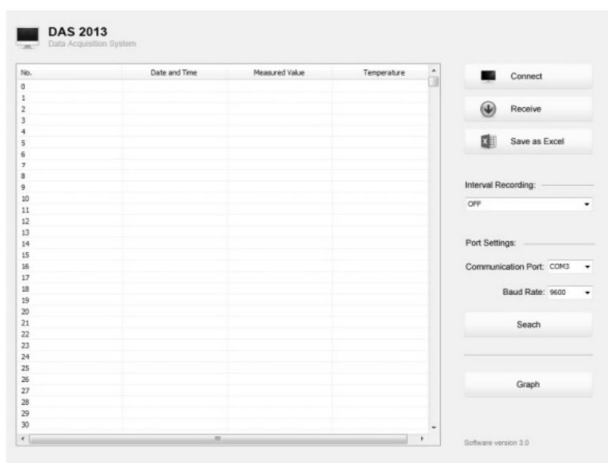

- Click the **Connect** button, the screen shows "Port is connected" indicate that the communication between the meter and the computer has been established.
- Click the **OK** button to confirm.
- Click the **Receive** button, the stored data automatically transfer to computer.

Interval recording

This function is used for recording the measuring value within the specify time period.

- Click the **Interval Recording** button and select a time option.
- Click the **Receive** button, the measured value will automatically send to data sheet.



- The first data need 1 minute to be shown on screen.
- Do not press any key on meter during the Interval Recording mode, it will cause communication interruption.

Graph mode

This function is used for viewing the variations of the measured parameter continuously.

Click the **Graph** button, the screen immediately shows the curve graph. To quit current mode, click the **Back** button.

Create the excel file

When the transfer is completed, click the **Save as Excel** button, the measured values in the data sheet will automatically convert to Excel file.



- Once the software is closed, all received data will be lost and can not be recovered.

Electrode Care and Maintenance

- DO NOT touch the measurement area of electrode and always make sure that is clean.
- If there is a build-up of solids inside the measurement area, these should be removed very carefully with a cotton bud soaked in solvent, taking care not to touch the metal parts of the inner cell. After the solids are removed, the electrode must be recalibrated.

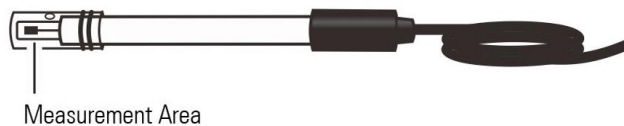

Troubleshooting

LCD DISPLAY	CAUSE	CORRECTIVE ACTION
---	Electrode dried out	Soak the conductivity electrode in tap water for 10 minutes.
	Measured value is out of range	Check the electrode whether dirty or broken.
Err	Electrode does not suit the current sample	Replace the conductivity electrode.
	Setting value does not match calibration solution	Reset the calibration value or check the calibration solution.
	Electrode is broken	Replace the conductivity electrode.

Specifications

Conductivity	Model	Bante950
	Range	0.01~20.00, 200.0, 2000 μ S/cm, 20.00, 200.0mS/cm
	Accuracy	\pm 0.5% F.S
	Resolution	0.001, 0.01, 0.1, 1
	Calibration Points	1 to 5 points
	Calibration Solutions	10 μ S/cm, 84 μ S/cm, 1413 μ S/cm, 12.88mS/cm, 111.8mS/cm
TDS	Range	0~10.00, 100.0, 1000ppm, 10.00, 100.0ppt (Max. 200ppt)
	Accuracy	\pm 1% F.S
	TDS Factor	0.1~1.0 (Default 0.5)
Salinity	Range	0.00~80.00ppt, 0.00~42.00psu
	Accuracy	\pm 1% F.S
	Measurement Modes	Practical Salinity (psu) or Natural Seawater (ppt)
Resistivity	Range	0.00~20.00M Ω
	Accuracy	\pm 1% F.S
	Resolution	0.01, 0.1, 1
Temperature	Range	0~105°C, 32~221°F
	Accuracy	\pm 0.5°C
	Resolution	0.1°C
	Calibration Points	1 point
General	Temperature Compensation	0~100°C, 32~212°F, Manual or Automatic
	Temperature Coefficient	0.0~10.0%/°C
	Compensation Modes	Linear or Pure Water
	Cell Constant	K=0.1, 1, 10 or User-Defined
	Reference Temperature	20°C or 25°C
	Memory	Stores up to 500 data sets
	Output	USB communication interface
	Connector	6-pin
	Operating Temperature	0~60°C
	Relative Humidity	< 80%
	Power Requirements	DC5V, using AC adapters, 220VAC/50Hz
	Dimensions	210 (L) \times 188 (W) \times 60 (H)mm
Weight	1.5kg	

Addendum 1: Preparation of Conductivity Standard Solutions

Place AR potassium chloride reagent in a 50ml beaker and dry in an oven for 3 to 5 hours at 105°C, then cool to room temperature in desiccator.

CALIBRATION SOLUTIONS	REAGENT
84µS/cm	Accurately weigh out 42.35mg of KCL and dissolve in 1 litre deionised water.
1413µS/cm	Accurately weigh out 745.9mg of KCL and dissolve in 1 litre deionised water.
12.88mS/cm	Accurately weigh out 7.45g of KCL and dissolve in 1 litre deionised water.
111.8mS/cm	Accurately weigh out 74.5g of KCL and dissolve in 1 litre deionised water.

Stir the solution until the reagent has thoroughly mixed. Preparation is completed.

Addendum 2: How to calculate the temperature coefficient

To determine the temperature coefficient of sample solution use the formula below:

$$T_c = \frac{C_{TB} - C_{TA}}{C_{TA}(T_B - 25) - C_{TB}(T_A - 25)} \times 100\%$$

Where:

T_c = Temperature coefficient

C_{TA} = Conductivity at Temperature A

C_{TB} = Conductivity at Temperature B

T_A = Temperature A

T_B = Temperature B

1. Press and hold the °C key for 3 seconds to enter the temperature setting.
2. Press the ▲ or ▼ key to set the temperature to 25°C.
3. Place the electrode into the sample solution A and record the temperature value T_A and conductivity value C_{TA} .
4. Condition the sample solution and electrode to a temperature that is about 5°C to 10°C different from T_A . Record the temperature value T_B and conductivity value C_{TB} .
5. Calculate the temperature coefficient according to the formula above.

Addendum 3: How to calculate the TDS conversion factor

To determine the TDS conversion factor use the formula below:

$$\text{Factor} = \frac{\text{Actual TDS}}{\text{Actual Conductivity @ 25°C}}$$

Where:

Actual TDS: value from the high purity water and precisely weighed NaCl or KCL reagent.

Actual Conductivity: the meter measured conductivity value.

For example: dissolve 64g of potassium chloride reagent in 1 litre distilled water. If its conductivity value is 100mS/cm, then TDS conversion factor is 0.64.

Hazardous Substance Statement

Instruments is committed to the reduction and eventual elimination of all hazardous substances in both the manufacturing process and finished products we supply. We have an active manufacturing and procurement program to minimize and eliminate the use of harmful heavy metals such as cadmium, lead, mercury and the like. New technologies and design parameters are also promoting these efforts and we expect to have little or no such materials in our product in the coming years. We welcome our customer suggestions on how to speed up these efforts.



Warranty

The warranty period for meter is one year from the date of shipment. Above warranty does not cover the sensor and calibration solutions. Out of warranty products will be repaired on a charged basis. The warranty on your meter shall not apply to defects resulting from:

- Improper or inadequate maintenance by customer.
- Unauthorized modification or misuse.
- Operation outside of the environment specifications of the products.

For more information, please contact the nearest authorized distributor.